

PUNJAB PUBLIC SERVICE COMMISSION

Competitive Examination (February-2017) for Recruitment of Sub Divisional Engineers (Electrical) in the Department of Public Works, Government of Punjab.

READ INSTRUCTIONS BEFORE FILLING ANY DETAILS OR ATTEMPTING TO ANSWER THE QUESTIONS.

Candidate's Name _____

Father's Name _____

Date of Birth

DD MM YYYY

Category Code*

(*as given in the admit card)

OMR Response Sheet No. _____

Roll No. _____

Booklet No.

Candidate's Signature (Please sign in the box)

INSTRUCTIONS

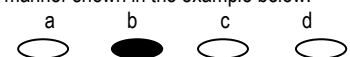
<p>1. The candidate shall NOT open this booklet till the time told to do so by the Invigilation Staff. However, in the meantime, the candidate can read these instructions carefully and subsequently fill the appropriate columns given above in CAPITAL letters. The candidate may also fill the relevant columns (other than the columns related to marking responses to the questions) of the Optical Mark Reader(OMR) response sheet, supplied separately</p>	<p>9. The candidates shall be responsible to ensure that the responses are marked in correct manner and any adverse impact due to wrong marking of responses would be the responsibility of the respective candidate. The following are some of the examples of wrong marking of responses on the OMR response sheet.</p> <div style="text-align: center;">  </div>
<p>2. Use only blue or black ball point pen to fill the relevant columns on this page. Use of fountain pen may leave smudges which may make the information given by the candidate here illegible.</p> <p>3. The candidate shall be liable for any adverse effect if the information given above is wrong or illegible.</p>	<p>10. The candidates, when allowed to open the question paper booklet, are advised to check the booklet to confirm that the booklet has complete number of pages, the pages printed correctly and there are no blank pages. In case there is any such error in the question paper booklet then the candidate should immediately bring this fact to the notice of the invigilation Staff and obtain a booklet of the same series as this one.</p>
<p>4. Before attempting the paper, the candidate must fill all the columns given above on this page and sign at the appropriate place.</p> <p>5. Each candidate is required to attempt 100 questions in 120 minutes, except for visually impaired candidates, who would be given 40 minutes extra, by marking correct responses on the OMR sheet which would be supplied separately to the candidates.</p>	<p>11. The serial number of the new booklet should be entered in the relevant column of the OMR. The candidate should request the Invigilation Staff to authenticate the change in serial number of question booklet by obtaining the initials of the Staff on the corrected serial number of the question booklet</p>
<p>6. The candidate must write the following on the OMRs sheet: (a)Serial number of OMR sheet supplied to him/her for marking the responses to the questions. (b)Serial number of the question booklet Failure to do so may lead to cancellation of candidature or any other action which the Commission may deem fit.</p>	<p>12. The question paper booklet has 17 pages.</p> <p>13. Each question shall carry three marks.</p>
<p>7. The candidate should darken the appropriate response to the question by completely darkening the appropriate circle/oval according to his/her choice of response i.e. a, b, c or d in the manner shown in the example below.</p> <div style="text-align: center;"> <p>a b c d</p>  </div>	<p>14. There are four options for each question and the candidate has to mark the most appropriate answer on the OMR response sheet using blue or black ball point pen.</p>
<p>8. Partly darkening the circle/oval on the OMR response sheet or using other symbols such as tick mark or cross would not result in evaluation of the response as the OMR scanner can only interpret the answers by reading the darkened responses in the manner explained in preceding paragraph. Darkening more than one circle/oval as response to a question shall also be considered as wrong answer.</p>	<p>15. There is no negative marking for wrong answers or questions not attempted by the candidate.</p>

1. The switch in the circuit has been closed for a long time. It is opened at $t=0$. At $t=0^+$, the current through the capacitor is:

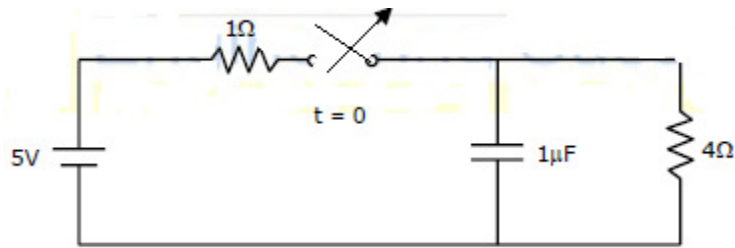

- a) 0 A
 b) 1 A
 c) 1.25 A
 d) 5 A
2. Two heaters, each rated at 1000 W, 250 V each are connected in series across a 250 V, 50 Hz ac mains. The total power drawn from the supply would be ___ W.

- a) 1000
 b) 250
 c) 500
 d) 2000

3. For the circuit shown in the figure, the reading of the voltmeter is :

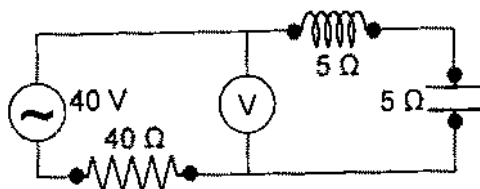

- a) 0 V
 b) 5 V
 c) 10 V
 d) -10 V

4. The Laplace transform $F(s)$ is $F(s) = \frac{2(s+1)}{s(s+a)}$. The inverse $f(t)$ as $t \rightarrow \infty$ has the value $\frac{1}{2}$.

Then 'a' is given by:

- a) 8
 b) 4
 c) 2
 d) 1

5. What is the Z-transform of the signal $x[n] = \alpha^n u(n)$?
- $\frac{1}{z-1}$
 - $\frac{1}{1-z}$
 - $\frac{z}{z-\alpha}$
 - $\frac{1}{z-\alpha}$
6. Which of the following cannot be the Fourier series expansion of a periodic signal?
- $x(t) = 2 \cos t + 3 \cos 3t$
 - $x(t) = 2 \cos \pi t + 7 \cos t$
 - $x(t) = \cos t + 0.5$
 - $x(t) = 2 \cos 1.5\pi t + \sin 1.5\pi t$
7. The Fourier transform of a rectangular pulse is:
- another rectangular pulse
 - triangular pulse
 - sinc function
 - impulse function
8. A second order system exhibits 100 % overshoot. Its damping co-efficient is:
- equal to zero
 - equal to 1
 - less than 1
 - greater than 1
9. The root loci of a system has three asymptotes; the systems can have:
- five poles and two zeros
 - four poles and one zero
 - three poles
 - all of the above
10. The system with open loop transfer function $\frac{1}{s(1+s)}$ is:
- type 2 and order 1 system
 - type 1 and order 1 system
 - type 0 and order 0 system
 - type 1 and order 2 system

11. Maxwell equation $\nabla \times \bar{E} = -\frac{\partial \bar{B}}{\partial t}$ is represented in integral form as:
- $\oint \bar{E} \cdot d\bar{l} = -\frac{\partial}{\partial t} \oint \bar{B} \cdot d\bar{l}$
 - $\oint \bar{E} \cdot d\bar{l} = -\frac{\partial}{\partial t} \oint_s \bar{B} \cdot d\bar{s}$
 - $\oint \bar{E} \times d\bar{l} = \frac{\partial}{\partial t} \oint \bar{B} \cdot d\bar{l}$
 - $\oint \bar{E} \times d\bar{l} = \frac{\partial}{\partial t} \oint_s \bar{B} \cdot d\bar{s}$
12. A parallel plate capacitor with air as dielectric medium has capacitance of 10 μF . If the linear dimensions of the plates are doubled and the separation between them is also doubled, the value of capacitor would be:
- 10 μF
 - 20 μF
 - 5 μF
 - 40 μF
13. The force experienced by a current carrying conductor lying parallel to a magnetic field is:
- zero
 - BIl
 - $BIl \sin \theta$
 - $BIl \cos \theta$
14. Superconductivity is destroyed:
- at high temperature
 - at high magnetic field
 - in presence of magnetic impurities
 - in all of the above cases
15. The primary function of a clamper circuit is to:
- introduce a dc level into ac signal
 - suppress variations in signal voltage
 - raise positive half cycle of the signal
 - lower negative half cycle of the signal
16. An operational amplifier possesses:
- very large input resistance and very large output resistance
 - very large input resistance and very small output resistance
 - very small input resistance and very small output resistance
 - very small input resistance and very large output resistance

17. NAND operation with x and y inputs is:
- $\overline{x + y}$
 - $\overline{x} + \overline{y}$
 - $\overline{x} \times \overline{y}$
 - $(\overline{x + y})(x + y)$
18. A Darlington emitter-follower circuit is sometimes used in the output stage of a TTL gate in order to:
- increase its I_{OL}
 - reduce its I_{OH}
 - increase its speed of operation
 - reduce power dissipation
19. A 12-bit ADC is operating with a $1\mu\text{s}$ clock period and total conversion time is seen to be $14\mu\text{s}$. The ADC must be of:
- flash type
 - counting type
 - integrating type
 - successive approximation type
20. A modulator is a device to:
- separate two frequencies
 - impress the information on to a radio frequency carrier
 - Extract information from the carrier
 - Amplify the audio frequency signal
21. With the increase in transmission bandwidth, received signal power in AM and FM will respectively:
- Increase, increase
 - Remain same, increase
 - Increase, remain same
 - Remain same, remain same
22. A bus organized processor consists of 15 registers. The number of selection lines in each multiplexer and in the destination decoder are respectively:
- 2 and 4
 - 4 and 2
 - 4 and 4
 - 4 and 8
23. A microprocessor based system can perform many different functions, because:
- its operation is controlled by software
 - it is digital system
 - it uses a RAM
 - it can be controlled by input and output devices

24. In a 3-phase power measurement by two wattmeter method the reading of one of the wattmeter was zero. The power factor of the load must be:
- a) unity
 - b) 0.5
 - c) 0.866
 - d) Zero
25. Dynamometer type wattmeters are suitable for:
- a) both ac & dc circuits
 - b) only ac circuits
 - c) only dc circuits
 - d) only high voltage ac circuits
26. The purpose of the synchronising control in a CRO is to:
- a) focus the spot on the screen
 - b) lock the display of signal
 - c) adjust the amplitude of display
 - d) control the intensity of the spot.
27. The full load copper loss and iron loss of a transformer are 6400 W and 5000 W respectively. The copper loss and iron loss at half load will be, respectively:
- a) 3200 W and 2500 W
 - b) 3200 and 5000 W
 - c) 1600 W and 1250 W
 - d) 1600 W and 5000 W
28. What is the frequency of rotor current of a 50 Hz induction motor operating at 2% slip?
- a) 1 Hz
 - b) 100 Hz
 - c) 2 Hz
 - d) 50 Hz
29. Floating neutral in a three phase supply is considered undesirable as it causes:
- a) high voltage across the load
 - b) low voltage across the load
 - c) unequal voltage across the load
 - d) none of the above
30. Four identical alternators each rated for 20 MVA, 11 KV having a sub transient reactance of 16% are working in parallel. The short circuit level at the bus bars is:
- a) 500 MVA
 - b) 400 MVA
 - c) 125 MVA
 - d) 80 MVA**

31. In distance protection, the relay measures:
- negative sequence impedance of the line from relay upto the fault point
 - positive sequence impedance of the line from relay upto the fault point
 - zero sequence impedance of the line from relay upto the fault point
 - negative, positive and zero sequence impedance of the line from relay upto the fault point
32. The output voltage of a zener diode rated as $12\text{ V} \pm 10\%$ tolerance is:
- 12.2 to 11.8 V
 - 13.2 to 10.8 V
 - only 12 V
 - none of these
33. The effect of source inductance on the performance of 1- \emptyset and 3- \emptyset full converter is to:
- reduce ripples in the load current
 - make the current continuous
 - reduce output voltage
 - increase the output voltage
34. For the circuit shown in the Figure, the steady voltage drop across the capacitor C is :

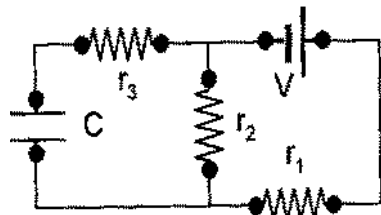

- $V(r_1) / (r_1 + r_2)$
 - $V(r_2) / (r_1 + r_2)$
 - $V(r_1 + r_2) / r_1$
 - $V(r_1 + r_2) / (r_1 + r_2 + r_3)$
35. In a series R-L circuit, the value of resistance is 1000 ohm and the applied voltage is $v(t) = 150\sqrt{2} \sin 500t$ V. If the RMS value of voltage across the resistor is 120 V, what is the value of inductance L?
- 0.5 H
 - 0.6 H
 - 1.0 H
 - 1.5 H

36. A rectangular current pulse of duration T and magnitude I has the Laplace transform:

- a) $\frac{I}{s}$
- b) $\frac{Ie^{-Ts}}{s}$
- c) $\frac{Ie^{Ts}}{s}$
- d) $\frac{I(1 - e^{-Ts})}{s}$

37. The open loop transfer function of a unity feedback control system is

$$G(s) = \frac{K}{s(s+1)(s+5)}$$

What is the value of K for its stable operation?

- a) $0 < K < 5$ only
 - b) $0 < K < 6$ only
 - c) $1 < K < 5$ only
 - d) $0 < K < 30$ only
38. Consider the following equation $2s^4 + s^3 + 3s^2 + 5s + 10 = 0$. How many roots does this equation have in the right half of the s -plane?
- a) one
 - b) two
 - c) three
 - d) zero
39. A parallel plate capacitor of 5 pF has a charge of 0.1 μC on its plates. what is the energy stored in the capacitor?
- a) 1 mJ
 - b) 1 μJ
 - c) 1 nJ
 - d) 1 pJ
40. The conductance of electrical circuit is analogous in magnetic circuit to:
- a) flux
 - b) reluctance
 - c) permeance
 - d) relative permeability

41. The hysteresis loop for the material of the core of a transformer should be:
- Short and narrow
 - Tall and narrow
 - Short and wide
 - Tall and wide
42. A half-wave rectifier having a resistance load of $1\text{ k}\Omega$ rectifies an ac voltage of 325 V peak value and the diode has a forward resistance of $100\ \Omega$. What is the RMS value of current?
- 295.4 mA
 - 94.0 mA
 - 147.7 mA
 - 208.0 mA
43. A single phase diode bridge rectifier supplies a highly inductive load. The load current can be assumed to be ripple free. The ac supply side current waveform will be:
- sinusoidal
 - constant dc
 - square
 - triangular
44. A non-inverting amplifier has input resistance $R_1 = 100\ \Omega$ and feedback resistance $R_f = 10\text{ k}\Omega$. Its gain value is:
- 10
 - 101
 - 100
 - 200
45. If the output of a logic gate is '1' when all its inputs are logic '0', the gate is either:
- a NAND or a NOR
 - an AND or an EX-NOR
 - an OR or a NAND
 - an EX-OR or an EX-NOR
46. Which one of the following logic families can be operated using a supply voltage from 3 V to 15 V ?
- TTL
 - ECL
 - PMOS
 - CMOS
47. A satellite channel can be fairly accurately modelled as a:
- Random delay channel
 - Panic button channel
 - Additive white Gaussian noise channel
 - Fading channel

48. Which one is the indirect addressing mode in the following instructions?
- a) LXIH 2050 H
 - b) MOV A, B
 - c) LDAX B
 - d) LDA 2050 H
49. A measured value of capacitor is 100 μF . The true value of the capacitor is 110 μF . The percentage relative error is:
- a) 9.99%
 - b) 9.09%
 - c) 10.0%
 - d) 4.76%
50. To measure low resistances, four terminals approach is preferred because it:
- a) eliminates the effect of thermoelectric emf
 - b) minimises the effects of parasitic capacitances
 - c) reduces the effects of parasitic inductances
 - d) eliminates the effects of lead and contact resistances
51. In performing short circuit test on a transformer, usually:
- a) high voltage winding is short circuited
 - b) low voltage winding is short circuited
 - c) both windings are short circuited
 - d) none of the winding is short circuited
52. The power factor of an induction motor operating at full load is likely to be:
- a) unity
 - b) 0.85 lead
 - c) 0.85 lag
 - d) 0.4 lag
53. The parameters of a transposed overhead transmission line are given as: self reactance $X_s=0.4$ ohm/km and mutual reactance $X_m=0.1$ ohm/km. The positive and zero sequence reactance respectively, in ohm/km are:
- a) 0.3, 0.2
 - b) 0.5, 0.2
 - c) 0.5, 0.6
 - d) 0.3, 0.6
54. A single line to ground fault occurs on an unloaded generator in phase 'a'. If $X_1=X_2=0.25$ pu and $X_0=0.15$ pu, reactance connected in the neutral $X_n=0.05$ pu and the initial prefault voltage is 1.0 pu, then the magnitude of the fault current will be:
- a) 3.75 pu
 - b) 1.54 pu
 - c) 1.43 pu
 - d) 1.25 pu

55. For a transmission line $V_s = AV_r + B I_r$, $I_s = C V_r + D I_r$ then I_r equals:

- a) $-C V_s + A I_s$
- b) $D V_s + A I_s$
- c) $D V_s - B I_s$
- d) $A V_s + D I_s$

56. The circuit in figure shows a full-wave rectifier. The input voltage is 230V (rms) single phase ac. The peak reverse voltage across the diode D_1 and D_2 is:

- a) $100\sqrt{2}$
- b) 100
- c) $50\sqrt{2}$
- d) 50

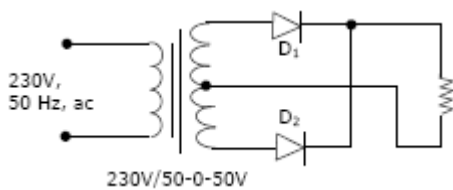

57. Piranha cleaning of a silicon wafer uses:

- a) H_2SO_4 and KOH.
- b) H_2SO_4 and H_2O_2 .
- c) KOH and NaOH.
- d) H_2O_2 and KOH.

58. Hydrogen passivation process is used for amorphous silicon thin films:

- a) To passivate silicon dangling bonds.
- b) To remove hydrogen from the Si-H bonds.
- c) To remove contaminations from the film.
- d) To break Si-Si bonds in the films.

59. In the figure shown, A_1 , A_2 and A_3 are ideal ammeters. If A_1 and A_3 read 5 and 13 A respectively. Reading of A_2 will be

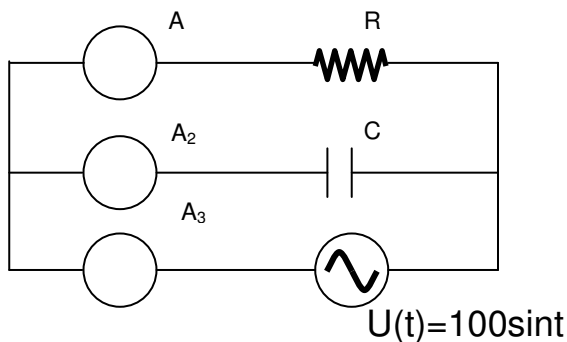

- a) 8 A
- b) 12 A
- c) 18 A
- d) Indeterminate unless the actual value of R, C and ω are specified

60. A series R-L-C circuit has a resistance of 47 ohm, inductance of 2 H and capacitance of 2 μ F. The supply voltage to the circuit is $v(t) = 10\sqrt{2} \sin 500t$ V. The RMS value of current through the circuit at resonance is _____
- 0.833 A
 - 0.212 A
 - 0.196 A
 - 0.000 A
61. Two wattmeters connected to measure the power in 3 phase balanced delta connected load read $W_1=12$ kW and $W_2=15$ kW. If same load be connected in star the wattmeter would read:
- $W_1= 8.66$ kW $W_2= 6.93$ kW
 - $W_1= 6.96$ kW $W_2= 8.66$ kW
 - $W_1= 5$ kW $W_2= 4$ kW
 - $W_1= 4$ kW $W_2= 5$ kW
62. What is the transfer function of a system whose impulse response is $e^{-3t} \sin 2t$?
- $\frac{13}{s^2 + 6s + 13}$
 - $\frac{1}{s^2 + 6s + 13}$
 - $\frac{2}{s^2 + 6s + 13}$
 - $\frac{2}{s^2 + 3s + 4}$
63. A closed loop system is stable for:
- Gain margin= 14 dB and Phase margin = 70°
 - Gain margin= -14 dB and Phase margin = 70°
 - Gain margin= 14 dB and Phase margin = -70°
 - Gain margin= -14 dB and Phase margin = -70°
64. If the characteristic equation of a closed-loop system is $s^2 + 2s + 2 = 0$, then the system is:
- over damped
 - critically damped
 - under damped
 - undamped
65. A control system has
- $$G(s)H(s) = \frac{K(s+1)}{s(s+3)(s+4)}$$
- Root locus of the system can lie on the real axis
- between $s = -1$ and $s = -3$
 - between $s = 0$ and $s = -4$
 - between $s = -3$ and $s = -4$
 - towards left of $s = -4$

66. In a parallel plate capacitor, a dielectric slab is introduced. Then the:
- potential difference between the plates will decrease
 - electric intensity will decrease
 - capacitance will increase
 - all of the above
67. Which one of the following is not a Maxwell's equation?
- $\nabla \times H = (\sigma + j\omega\epsilon)E$
 - $F = Q(E + v \times B)$
 - $\oint_C H \cdot ds = \int_S J \cdot ds + \int_S \frac{\partial D}{\partial t} \cdot ds$
 - $\oint_S B \cdot ds = 0$
68. Which of the following has zero temperature coefficient of resistance?
- Manganin
 - Nichrome
 - Carbon
 - Aluminium
69. The temperature coefficient of resistance of an insulator is:
- Positive and independent of temperature
 - Negative and independent of temperature
 - Negative and dependent of temperature
 - Positive and dependent of temperature
70. In a bridge ac to dc converter using P-N diodes, if the input voltage is $V \sin \omega t$, what is the peak inverse voltage across any diode?
- V
 - 2V
 - V/2
 - V/√2
71. The zero level detector is one application of a:
- differentiator
 - integrator
 - summing amplifier
 - comparator
72. The logic family which has minimum power dissipation is:
- TTL
 - I²L
 - ECL
 - CMOS

73. A pulse train can be delayed by a finite number of clock periods using:
- a) a serial-in serial-out shift register
 - b) a serial-in parallel-out shift register
 - c) a parallel-in serial out shift register
 - d) a parallel-in parallel-out shift register
74. A shift register with the serial output connected back to the serial input is a:
- a) feedback shift register
 - b) shift register counter
 - c) universal shift register
 - d) serial to parallel converter
75. An instruction used to set the carry Flag in a computer can be classified as:
- a) data transfer
 - b) arithmetic
 - c) logical
 - d) program control
76. The principle of operation of LVDT is based on variation of:
- a) self inductance
 - b) mutual inductance
 - c) reluctance
 - d) permeance
77. Maximum transient currents flow through a transformer winding when it is switched on with secondary_____ circuited and the input voltage wave is passing through the _____ value.
- a) open, zero
 - b) short, zero
 - c) open, maximum
 - d) short, maximum
78. In a DC machine, which loss increases rapidly with the increase in frequency of magnetic reversals?
- a) Copper loss
 - b) Hysteresis loss
 - c) Eddy current loss
 - d) Mechanical loss
79. The impedance value of a generator is 0.2 pu on a base value of 11 kV, 50 MVA. The impedance value for a base value of 22 kV, 150 MVA is:
- a) 0.15 pu
 - b) 0.2 pu
 - c) 0.3 pu
 - d) 0.4 pu

80. The capacitance and inductance p.u. length of a line operating at 110 kV are $0.01\mu\text{F}$ and 2mH . The surge impedance loading of the line is:
- a) 40 MVA
 - b) 30 MVA
 - c) 27 MVA
 - d) None of the above
81. A solar cell has a current density 35 mA/cm^2 and a voltage of 0.5 V . What is the efficiency of the cell when exposed to a sun light intensity 100 mW/cm^2 ?
- a) 16.5%
 - b) 17.5%
 - c) 18.5%
 - d) 6.5 %
82. A "sum" output in a half adder can be realized by using a single two input gate which should be:
- a) Exclusive OR gate
 - b) NOR gate
 - c) AND gate
 - d) OR gate
83. The unit of the mobility of an electron in a conductor is:
- a) $\text{cm}^2/\text{V-sec}$
 - b) $\text{cm}/\text{V-sec}$
 - c) cm^2/V
 - d) cm^2/sec
84. An electrostatic potential is given by $\phi = 2x(y)^{1/2}$ Volts in a rectangular co-ordinate system. The magnitude of the electric field at $x = 1\text{ m}$, $y = 1\text{ m}$ is:
- a) 5 V/m
 - b) 2 V/m
 - c) 2.236 V/m
 - d) 1.414 V/m
85. When a firing angle of a single phase fully controlled rectifier feeding constant DC current into the load is 30° . What is the displacement factor of the rectifier?
- a) 1
 - b) 0.5
 - c) 1.732
 - d) 0.866

86. What is the maximum output voltage of a 3-phase bridge rectifier supplied with line voltage of 440 V?
- a) 528 V
 - b) 396 V
 - c) 594 V
 - d) 616 V
87. A half wave rectifier has an input voltage of 240 V RMS. If the step down transformer has a turns ratio of 8:1, what is the peak load voltage? Neglect diode drop.
- a) 27.5 V
 - b) 86.5 V
 - c) 30.0 V
 - d) 42.5 V
88. The Boolean expression $X(P,Q,R) = \pi(0,5)$ is to be realised using only two 2-input gates. Which are these gates?
- a) AND and OR
 - b) NAND and OR
 - c) AND and XOR
 - d) OR and XOR
89. The figure of merit of a logic family is given by:
- a) gain x bandwidth.
 - b) propagation delay time x power dissipation.
 - c) fan-out x propagation delay time.
 - d) noise margin x power dissipation
90. In a common emitter amplifier, the unbypassed emitter resistance provides:
- a) voltage-shunt feedback
 - b) current-series feedback
 - c) negative-voltage feedback
 - d) positive current-feedback
91. In a uniform electric field, the field lines at equipotential surfaces:
- a) are parallel to one another
 - b) Intersect at 45°
 - c) Intersect at 30°
 - d) are orthogonal

92. A synchronous motor when operating in overexcited mode and connected across a load is used for:
- a) power factor improvement
 - b) efficiency improvement
 - c) torque improvement
 - d) current harmonic reduction
93. To operate a DC shunt motor at a speed above the rated speed, which of the following methods is preferred?
- a) armature resistance control
 - b) flux weakening control
 - c) supply voltage control
 - d) none of these methods
94. A buck regulator has an input voltage of 12 V and the required output voltage of 5 V. The duty cycle of the regulator is:
- a) 5/12
 - b) 12/5
 - c) 5/2
 - d) 6
95. Minimum number of JK flip-flops needed to construct a BCD counter is:
- a) 2
 - b) 3
 - c) 4
 - d) 5
96. A function in the time domain has half-wave symmetry. The Fourier series of the function will be made up of harmonics containing:
- a) odd cosine terms
 - b) odd sine terms
 - c) odd cosine and sine terms
 - d) none of these
97. Let $X(z) = 1/(1 - z^{-3})$ be the z-transform of a causal signal $x[n]$. Then the values of $x[2]$ and $x[3]$ are:
- a) 0 and 0
 - b) 0 and 1
 - c) 1 and 0
 - d) 1 and 1

98. Given two continuous time signals $x(t) = e^{-t}$ and $y(t) = e^{-2t}$ which exist for $t > 0$. The convolution $z(t) = x(t)*y(t)$ is:

- a) $e^{-t} - e^{-2t}$
- b) e^{-3t}
- c) e^t
- d) $e^{-t} + e^{-2t}$

99. An op-amp has an open-loop gain of 10^5 and an open loop upper cut-off frequency of 10 Hz. If this op-amp is connected as an amplifier with a closed loop gain of 100, then the new upper cut-off frequency is:

- a) 10 Hz
- b) 100 Hz
- c) 10 kHz
- d) 100 kHz

100. The highest frequency stability is achieved by using an oscillator of the type:

- a) Colpitts
- b) Crystal controlled
- c) Hartley
- d) RC oscillator
